

# A petri net-based modeling method for complex systems

JINGJING LIANG<sup>2</sup>, PIANPIAN MA<sup>2</sup>, JINJIANG LIU<sup>2,3</sup>,  
YAN TIAN<sup>2</sup>, XINGANG ZHANG<sup>2</sup>

**Abstract.** In order to construct simulation models and make quantifiable evaluations of complex systems, an analyzable Petri-net-based modeling method is proposed by introducing some factors such as fee and quality of life in the area of clinical medicine. After being used in modeling the clinical pathway of gastric cancer operation, this method is proved to be effective and reliable according to the experimental data including the figures about time, fee and the quality of life. Comparing with the actual data, the relative error is less than 5%.

**Key words.** complex system, stochastic petri net, time, fee, life quality, gastric cancer, clinical pathway.

## 1. Introduction

Clinical pathway is a new model of medical service. It is used to standardize treatment behaviors, and improve medical efficiency via the optimal timing and procedures, which are generated from the specific clinical pathway. The main purpose of this model is to reduce the days and fee during hospitalization [1].

Clinical pathway is a standard workflow, which involves almost all the staff from different departments. With mature mathematics technology, classical Petri net is good at dealing with all kinds of random events including synchronization, asynchronism, concurrence, and parallelism. Since the description is simple and clear, Petri net is suitable for the modeling and analysis of workflow [2, 3]. Based on work-

---

<sup>1</sup>Acknowledgement - The research of this paper is supported by the Institute of Image Processing & Pattern Recognition in Nanyang Normal University, and by the project of “Research into the Teaching methods of Algorithm courses” (No.2016-JXYJZD-01) in Nanyang Normal University, and by the Science and Technology Foundation of Henan Educational Committee of China (grant Nos.17A520049,17A630046). The authors thank all the anonymous reviewers for their helpful suggestions.

<sup>2</sup>Workshop 1 - School of Computer and Information Technology, Nanyang Normal University, Nanyang, Henan, China

<sup>3</sup>Corresponding author: Jinjiang Liu; e-mail: [nytc@sina.com](mailto:nytc@sina.com)

flow management system, Dwivedi et al. built a simulation model to simulate the clinical pathway[4]. They found out the key factors, which were later improved, to better the amangement efficiency of clinical pathway. Jrgensen used colored Petri net to establish models and analyze some sample cases. His research proves the universality and obvious advantages of Petri-net-based clinical pathway[5]. Sendi got the optimal resource configuration scheme by setting and revising parameters in a colored-Petri-net model[6]. Tianyan et al. presented a hierarchical price stochastic petri net (HPSPN) model to help calculate the duration and fee generated in hospital[7].

The researches mentioned above have properly solved some fundamental problems in clinical pathway modeling. It shows that Petri net has great potentials and advantages in this area. However, some difficulties still exist. First, cancer is too complicated and time-consuming to be well simulated in Petri net model. Second, the overall treatment effect is greatly affected by the attitudes and cooperation of the patients, who are easily influenced by two factors: how long they will stay in hospital and how much they will spend. Duration and fee generated in hospital have not been introduced in existing models, so a lot of work should be done before it is put into practical use. This paper presents a hierarchical Petri-net-based modeling method by introducing more factors in order to make the modeling and analyzing of the clinical pathway easier and more accurate.

## 2. Definition of HPQSPN

### 2.1. PQSPN

PQSPN is a stochastic Petri net, which involves factors as fee and grade of life quality.

In clinical practice, the grading of life quality is performed at scheduled time intervals. It is not related to each diagnosis and treatment behavior. In order to make the model unified and easy, set  $q$  to zero for the transitions which are not graded.

### 2.2. HPQSPN

In a hierarchical petri net, a simple description of each sub procedure is given in top model by using elaboration theory to deal with complex problems. The details will be presented in the lower layer. Top-down and bottom-up methods are always used when establishing a hierarchical petri net, where each layer is also a stochastic Petri net.

**Definition 2:**  $HPSPN = (S, SN, SA, PN, PT, PA, FS, FT, PT)$ [10-11], where each element is defined as follows:

1.  $S$  is a finite set of pages, for each  $s \in S$  is a PSPN;
2.  $SN \subseteq T$  a set of substitution nodes;

3.  $SA$  represents the page allocation function;
4.  $PN \subseteq P$  is a set of port nodes;
5.  $PT$  is a function about port types;
6.  $PA$  is used to indicate the function of ports allocation;
7.  $FS$  is a finite joint set;
8.  $FT$  is a joint class function;
9.  $PP$  is a multiset used to define the home page.

### 3. Calculation of time and expense in HPSPN

From Definition 1 and 2, we can learn that HPSPN is essentially a stochastic petri net in which prices of all medical behaviors during hospitalization are introduced as a new factor. We will focus on the discussion about the performance of time and expense in HPSPN from the perspective of four basic models.

#### 3.1. Serial model of HPSPN

The workflow of serial model describes a series of ordered activities, as shown in Fig.1.

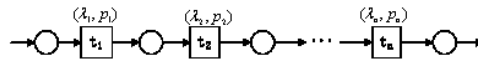

Fig. 1. serial model of HPSPN

Theorem 1: Suppose  $n$  independent stochastic variables each represent the execution time of  $n$  serial transitions, which follow the exponential distribution with parameters of  $\lambda_1, \lambda_2, \dots, \lambda_n$ . Hence the average execution time of these transitions are  $\frac{1}{\lambda_1}, \frac{1}{\lambda_2}, \dots, \frac{1}{\lambda_n}$  with the following equivalent total execution time:

$$\frac{1}{\lambda} = \sum_{i=1}^n \frac{1}{\lambda_i} [12]$$

Theorem 2: Suppose  $p_1, p_2, \dots, p_n$  each represents the execution expense of  $n$  serial transitions, the equivalence of total execution expense can be described as follows:

$$P = \sum_{i=1}^n p_i$$

Proof: from Theorem 1 and 2, we can derive the following expression:

$$P = p_1 + p_2 + p_3 + \dots + p_i = \sum_{i=1}^n p_i$$

### 3.2. Parallel Model of HPSPN

Parallel model is used to define the workflow of unordered and parallel activities, as shown in Fig.2.

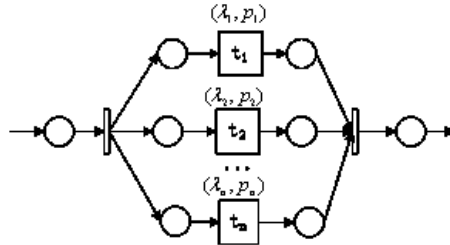

Fig. 2. parallel model of HPSPN

Theorem 3: Suppose n independent stochastic variables each represent the execution time of n parallel transitions, which follow the exponential distribution with parameters of  $\lambda_1, \lambda_2, \dots, \lambda_n$ . Hence the average execution time of these transitions are  $\frac{1}{\lambda_1}, \frac{1}{\lambda_2}, \dots, \frac{1}{\lambda_n}$  with the following equivalent total execution time:

$$\frac{1}{\lambda} = \sum_{i=1}^n \frac{1}{\lambda_i} - \sum_{i=1}^{n-1} \sum_{j=i+1}^n \frac{1}{\lambda_i + \lambda_j} + \sum_{i=1}^{n-2} \sum_{j=i+1}^{n-1} \sum_{k=j+1}^n \frac{1}{\lambda_i + \lambda_j + \lambda_k} + \dots + (-1)^{n-1} [12]$$

Theorem 4: Suppose  $p_1, p_2, \dots, p_n$  each represents the execution expense of n parallel transitions, the equivalence of total execution expense can be described as follows:

$$P = \sum_{i=1}^n p_i$$

Proof: According to inclusion-exclusion principle, assume that  $C_1, C_2, \dots, C_n$  is finite set, then:

$$\begin{aligned} |C_1 \cup C_2 \cup \dots \cup C_n| &= \sum_{i=1}^n |C_i| - \sum_{i=1}^n \sum_{j>i} |C_i \cap C_j| \\ &\quad + \sum_{i=1}^n \sum_{j>i} \sum_{k>j} |C_i \cap C_j \cap C_k| \\ &\quad + (-1)^{n-1} |C_1 \cap C_2 \cap \dots \cap C_n| \end{aligned} \tag{1}$$

Based on Formula(1), we can derive the following conclusion:

$$\begin{aligned} P &= |p_1 \cup p_2 \cup \dots \cup p_n| \\ &= \sum_{i=1}^n |p_i| - \sum_{i=1}^n \sum_{j>i} |p_i \cap p_j| \\ &\quad + \sum_{i=1}^n \sum_{j>i} \sum_{k>j} |p_i \cap p_j \cap p_k| \\ &\quad + (-1)^{n-1} |p_1 \cap p_2 \cap \dots \cap p_n| \end{aligned} \tag{2}$$

**3.3. Selection model of HPSPN**

Selection model is used to simulate the activities that are mutually restricted or exclusive. Among these paths, only one will be selected in accordance with specific conditions, as shown in Fig.3.

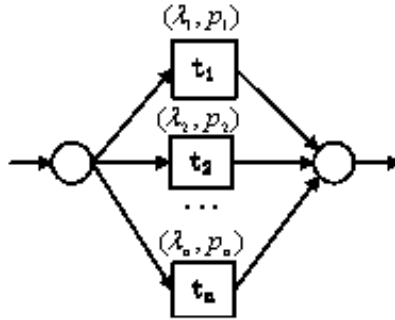

Fig. 3. Selection model of HPSPN

Theorem 5: Suppose n independent stochastic variables each represent the execution time of n selection transitions, which follow the exponential distribution with parameters of  $\lambda_1, \lambda_2, \dots, \lambda_n$ . Hence the average execution time of these transitions are  $\frac{1}{\lambda_1}, \frac{1}{\lambda_2}, \dots, \frac{1}{\lambda_n}$ , while  $\gamma_i$  is the execution rate of  $t_i$ . The total execution time is as follows:

$$\frac{1}{\lambda} = \sum_{i=1}^n \frac{\gamma_i}{\lambda_i} [12]$$

Theorem 6: Suppose  $p_1, p_2, \dots, p_n$  each represents the execution expense of n selection transitions, while  $\gamma_i$  is the execution rate of  $t_i$  with  $\sum_{i=1}^n \gamma_i = 1$ . The equivalence of total execution expense can be described as follows:

$$P = \sum_{i=1}^n (\gamma_i \times p_i)$$

Proof: from Theorem 5 and 6, we can derive the following expression:

$$P = p_1 \times \gamma_1 + p_2 \times \gamma_2 + \dots + p_n \times \gamma_n = \sum_{i=1}^n (\gamma_i \times p_i) \tag{3}$$

**3.4. Loop model of HPSPN**

Loop model is for repetitive tasks, as shown in Fig.4.

Theorem 7: Suppose a loop structure is composed of two transitions  $t_1, t_2$ , and two independent variables each represent their execution time, which follow the exponential distribution.  $\frac{1}{\lambda_1}, \frac{1}{\lambda_2}$  are the average execution time of  $t_1, t_2$ , while  $\gamma$  is the execution rate of  $t_2$ , then we can get the equivalent total execution time

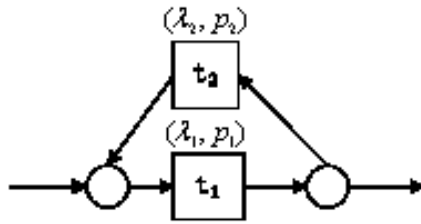

Fig. 4. Loop model of HPSPN

$$\frac{1}{\lambda} = \frac{1}{1-\gamma} \times \left( \frac{\gamma}{\lambda_2} + \frac{1}{\lambda_1} \right) [12]$$

Theorem 8: Let \$p\_1, p\_2\$ be the average expense of loop transitions \$t\_1, t\_2\$, and \$\gamma\$ be the execution rate of \$t\_2\$ then we can derive the average expense of the two transitions as follow:

$$P = \frac{\gamma \times p_2}{1-\gamma} + \frac{p_1}{1-\gamma}$$

**Proof:** Let \$(1-\gamma)\gamma^n\$ be the rate of repeating \$t\_2\$ for \$n\$ times. The total expense is composed of that produced from executing \$t\_1\$ for \$n+1\$ times and \$t\_2\$ for \$n\$ times. That is, \$n \times (p\_1 + p\_2) + p\_1\$

$$\begin{aligned} P &= \sum_{i=0}^{\infty} (1-\gamma)\gamma^i (p_2 \times i + p_1 \times (i+1)) \\ &= (1-\gamma) \times \sum_{i=0}^{\infty} \gamma^i (p_2 \times i + p_1 \times (i+1)) \\ &= (1-\gamma) \times \left( \sum_{i=0}^{\infty} \gamma^i \times p_2 \times i + \sum_{i=0}^{\infty} \gamma^i p_1 (i+1) \right) \\ &= (1-\gamma) \times \left( \frac{\gamma \times p_2}{(1-\gamma)^2} + \frac{p_1}{(1-\gamma)^2} \right) \\ &= \frac{\gamma \times p_2}{1-\gamma} + \frac{p_1}{1-\gamma} \end{aligned} \tag{4}$$

#### 4. HPQSPN-based modeling of clinical pathway of gastric cancer operation

Taking the clinical pathway of gastric cancer operation as the research object, some key figures about duration and fee are acquired from the modeling based on HPQSPN. Fig.5 shows the process of diagnosis and treatment for gastric cancer based on NCCN.

##### 4.1. Combination of transitions and system transformation

In clinical practice, latency time is inevitable in every step, and that also contributes to the final expense in hospital. Especially for those inpatients, they have to pay extra money for the beds, the nursing care and the garbage disposal. That means the longer they stay in hospital, the more they will spend. There for, the latency time should be introduced into this model. The revised model is shown in Fig.6.

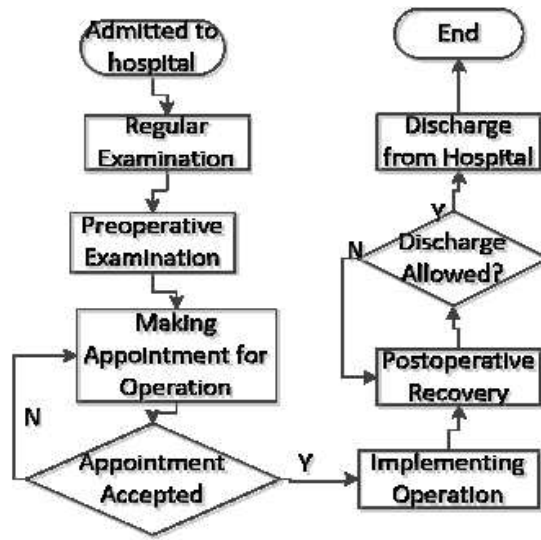

Fig. 5. Process of clinical pathway for gastric cancer

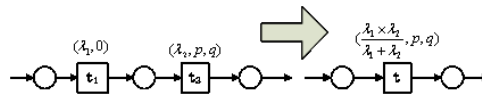

Fig. 6. Combination of waiting and treatment behaviors

In Fig.2,  $t_2$  represents a routine treatment behavior; while the fee it produces is indicated by the symbol  $p$ .  $\lambda_2$  is the average rate of  $t_2$  and  $t_1$  is the latency time with  $t_1$  as its average rate. Transition  $t$  is the result of the combination of treatment and latency, so it is obvious that the revised system is still a PSPN. We can get the following conclusions:

(1) The average latency time of transition  $t$  is  $\frac{1}{\lambda_1} + \frac{1}{\lambda_2}$ , and the expense it produces is  $p$ ;

(2) Suppose that  $\omega$  is the expense of unit latency time, then the total expense can be described by the following expression:

$$P = \omega \times \left( \frac{1}{\lambda_1} + \frac{1}{\lambda_2} \right) + p \tag{5}$$

According to Fig.5 and Fig.6, we can get a top Petri net to simulate the clinical pathway of gastric cancer, which is shown in Fig.7. This model has been greatly simplified by adding the average latency time to the corresponding treatment behaviors. A lot of work should be done in the refinement phase.

Taking Transition  $t_{10}$ (postoperative chemotherapy) for example, Fig.8 below shows its refined subnet, which has presented all the important information, such as the meanings of all transitions, execution time and expense. For example, Transition  $t_5$ , standing for LEP in postoperative chemotherapy, will last for 8 days with the total expense of 4559 yuan.

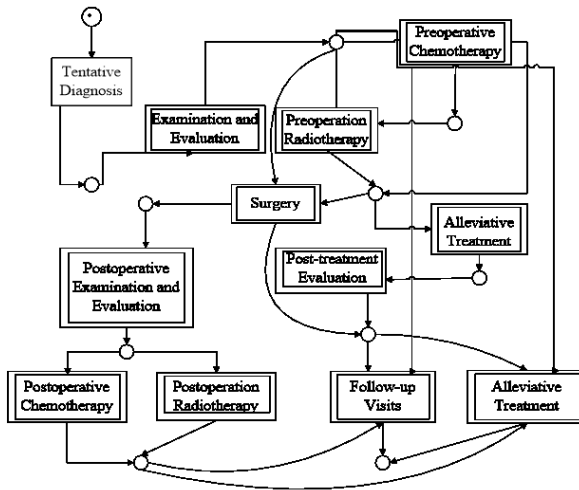

Fig. 7. Top petri net of clinical pathway

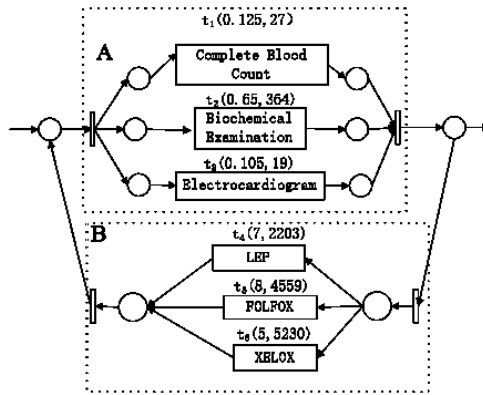

Fig. 8. Petri subnet of postoperative chemotherapy for gastric cancer

Let's take Fig.8 for example. Subsystem A and B compose the petri subnet that represents the process of postoperative chemotherapy, in which A is a parallel model consisting of  $t_1, t_2$  and  $t_3$ ; while B is a selection model made up of  $t_4, t_5,$  and  $t_6$ . The following calculation is performed based on Theorem 1-8.

Let  $t_A$  be the equivalent transition of Subsystem A, and  $t_B$  be the equivalent transition of B. The execution rates of  $t_4, t_5$  and  $t_6$  are 0.1, 0.7 and 0.2. Suppose that the room charge  $\omega$  is 56 yuan per day, according to Theorem 3, the execution time of  $t_A$  can be derived as follows:

From Theorem 5, we can get the execution time of  $t_B$  as follows:

$$\frac{1}{\lambda}(t_B) = 7 \times 0.1 + 8 \times 0.7 + 5 \times 0.2 = 7.3(days)$$



According to Theorem 6, the execution expense of  $t_B$  is:

$$P_{t_B} = 2203 \times 0.1 + 4559 \times 0.7 + 5230 \times 0.2 = 4457.6(\text{yuan})$$

The total execution time is acquired via Theorem 7:

$$\frac{1}{\lambda} = \frac{1}{1 - \gamma_B} \times \left( \frac{\gamma_B}{\lambda_B} + \frac{1}{\lambda_A} \right) = \frac{1}{1 - 0.784} \times (0.784 \times 7.3 + 0.680) = 29.64(\text{days})$$

From Theorem 8, the total expense of all equivalent transitions can be described as follows:

$$P = \frac{\gamma_B \times p_B}{1 - \gamma_B} + \frac{p_A}{1 - \gamma_B} = \frac{0.784 \times 4457.6}{1 - 0.784} + \frac{406}{1 - 0.784} = 18059.07(\text{yuan})$$

According to Formula (??), the final total expense of the whole system is:

$$P = 56 \times 29.64 + 18059.07 = 19718.91(\text{yuan})$$

The total execution time can be acquired in the same way above.

### 4.2. Layered Modeling

The diagnosis and treatment process of gastric cancer is complicated, so the traditional modeling method is not suitable. We choose a layered top-down refinement method to build a simulation model. According to the principles of system transformation and combination which are proposed in 2.1, we get a top-level Petri net of clinical pathway for gastric cancer shown in Fig.9.

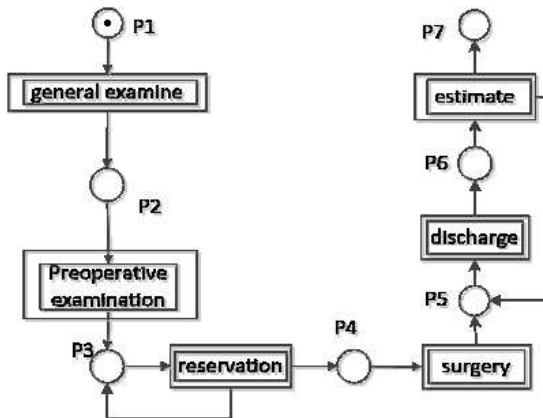

Fig. 9. Top-level petri net of clinical pathway for gastric cancer

As shown in Fig.9, the average waiting time of each transition is merged into the corresponding diagnosis and treatment behavior, so that the Petri model is greatly simplified. Transitions in this figure need further refinement.

### 5. Performance Calculation of HPQSPN

From Definition 1 and 2, we can see that factors introduced in this now model, such as fee and life quality, have no influence on the overall function analysis. Like classical Petri net, HPQSPN is also comprised of four basic models: Serial, Parallel, Selection and Loop model.

Suppose a system consists of n transitions, and the execution time of each transition is independent and stochastic. The values of time are under exponential distribution as  $\lambda_1, \lambda_2, \dots, \lambda_n$ , and the average values of execution time of these transitions are  $\frac{1}{\lambda_1}, \frac{1}{\lambda_2}, \dots, \frac{1}{\lambda_n}$ .  $p_1, p_2, \dots, p_n$  are mutually independent variables, which represent the fees for each transition. In addition,  $\mu$  is the fee caused by latency. The execution time and fee are described in the formulas shown below [7, 12]:

$$T = \frac{ab}{2} \rho_0 h_0 \omega^2 \int_A p_1 p_2 \left[ 1 - (1 - \beta) \left( \xi + \frac{1}{2} \right)^2 \right] w^2 dA \tag{6}$$

In actual diagnosis and treatment process, the life qualities of patients are always graded by doctors at regular intervals. For the sake of convenience,  $q$  of the transition which leads to no grading will be set to zero. The average grading value of life qualities will be working out according to the following steps:

- Step 1: initialize the system by setting  $q\_sum = q\_sum + q$  and  $q\_count$  (times of grading) to zero;
- Step 2: enter the clinical pathway;
- Step 3: get the value of  $q$  from current transition;
- Step 4: if  $q \neq 0$ , then  $q\_sum = q\_sum + q, q\_count = q\_count + 1$ ;
- Step 5: repeat Step 3 and 4 until leave the pathway;
- Step 6: calculate the grade by using the following formula:  $q\_sys = \frac{q\_sum}{q\_count}$ .

### 6. Experiments and Simulation

Results shown in Table 1 are acquired by simulating the model in Fig.3 on CPN Tools 3.4.0.

Table 1. Comparison between simulation values and actual values

Items	Simulation statistics	Actual statistics	Relative error??%??
Time day	7.26	6.92	4.91
Feeyuan	34084.94	32547.33	4.72
Life quality score	77.37	79.92	3.19

Data in Table 1, where the simulation and acutal statistics are very close with a relative error of less than 5%, proves the effectiveness and feasibility of this HPQSPN-based method.

Five treatment strategies are formulated targeted at five gastric cancer cases in a hospital. Figures below are generated during the modeling via HPSPN and simulation test on CPN Tools 3.4.0

Table 2. Petri subnet of postoperative chemotherapy for gastric cancer

	Days	Expense (yuan)	Expense for Treatment	Total Expense (yuan)	Ex-Expense for Treatment/Total Expense
Scheme1	47.3	2648.8	58500.6	61149.4	95.67%
Scheme2	50.7	2839.2	71141	73980.2	96.16%
Scheme3	52.1	2917.6	67163.7	70081.3	95.84%
Scheme4	49.6	2777.6	67364.3	70141.9	96.04%
Scheme5	54.1	3029.6	74368.9	77398.5	96.09%

From Table 2, we can tell that Strategy 1 has a minimum of both time and money, while Strategy 5 is on the contrary. Expense of each treatment strategy is at least 3% lower than the original expense. On the premise that the treatment effect can be ensured, it is suggested that Strategy 2 should be properly improved to be put into practical use. We can also make decisions in accordance with specific conditions. Since most of the patients in this hospital are from countryside, Strategy 1 may be the best choice.

## 7. Conclusions

Clinical pathway is a new medical care model. It is used to standardize treatment behaviors, and improve medical efficiency via the optimal timing and procedures, which are generated from the specific clinical pathway. The main purpose of this model is to reduce the days and fee during hospitalization.

This paper presents a hierarchical Petri net(HPQSPN)by introducing some key factors as fee and life quality in clinical pathway. The complicated system is greatly simplified by layering the working process. According to four basic models, the corresponding calculating methods are given in accurate formulas. Then we carried out experiments in the treatment of gastric cancer, and this HPQSPN-based method is proved to be effective. For further study, we will introduce more factors about medical resources involving doctors, nurses, operating theatres and so on, in order that all the resources can be better allocated and optimized.

## References

- [1] L. BRAGATO, K. JACOBS: *Care pathways: The road to better health services*. Journal of Health Organization and Management 17 (2003), No. 3, 164–180.
- [2] J. CHEAH: *Development and implementation of a clinical pathway program in an*

- acute care general hospital in Singapore*. International Journal for Quality in Health Care 12 (2000), No. 5, 403–412.
- [3] M. P. ASLST: *The application of Petri nets to workflow management*. Journal of Circuits 8 (1998), No. 1, 21–66.
  - [4] A. DWIVEDI, R. K. BALI, A. E. JAMES: *Workflow management systems: The health-care Technology of the future annual*. Reports of the Research Reactor Institute 4 (2001), 3887–3890.
  - [5] J. JORGENSEN: *Coloured Petri nets in development of apervasive health care system*. Lecture Notes in Computer Science (2003), 256–275.
  - [6] P. SENDI, J. A. MAIWEN, M. BATTEGAY: *Optimising the performance of an outpatient setting*. Swiss Medical Weekly 134 (2004) 44–49.
  - [7] T. YAN, J. L. JING, D. W. YANG: *Analysis of Clinical Pathway via Price Stochastic Petri Net*. Sadhana 8 (2013), No. 5, 147–155.
  - [8] M. KLEIN, C. DELLAROCAS, A. BERNSTEIN: *Introduction to the special issue on adaptive workflow system*. ComPuter Supported cooperative work 9 (2009), 265–267.
  - [9] A. FRONK, B. KEHDEN: *State space analysis of Petri nets with relation-algebraic methods*. Journal of Symbolic Computation 44 (2009), No. 1, 15–47.
  - [10] T. SYLVIE, P. C. JEAN, B. GILLES: *Modeling and verification with timed hybrid Petri nets*. Pattern Recognition 42, (2009), 562–566.
  - [11] L. FRIGERIO, K. MARKS, A. KRIKELIS: *Timed coloured Petri nets for performance evaluation of DSP applications: The 3GPP LTE case study*. Design Methodologies for SoC and SiP 313 (2013), No. 5, 114–132.
  - [12] L. CHUANG, Q. U. YANG, F. Y. REN : *Performance Equivalent Analysis of Workflow Systems Based on Stochastic Petri Net Models*. Lecture Notes in Computer Science 2480 (2002), 64–79.

Received November 16, 2016